



- DIN EN 175301-803
- 2+PE, 3+PE
- Low and high housing
- Degree of protection IP65
- Wired versions
- Moulded versions
- Degree of protection IP67

Description

Female power connector, low housing



Drawing

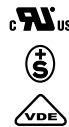
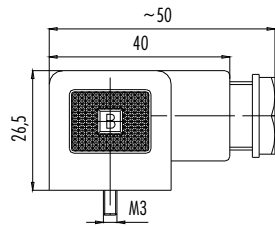

Contacts	Thread	Cable outlet	Ordering-No.
2+PE	PG 9	6–8 mm	43 1700 000 03
	M16	6–10 mm	43 1700 004 03
	PG 11	8–10 mm	43 1700 002 03
3+PE	PG 9	6–8 mm	43 1702 000 04
	M16	6–10 mm	43 1702 004 04
	PG 11	8–10 mm	43 1702 002 04

Female power connector, high housing

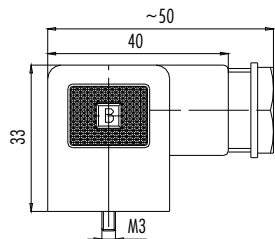

2+PE	PG 9	6–8 mm	43 1704 000 03
	M16	6–10 mm	43 1704 004 03
	PG 11	8–10 mm	43 1704 002 03
3+PE	PG 9	6–8 mm	43 1706 000 04
	M16	6–10 mm	43 1706 004 04
	PG 11	8–10 mm	43 1706 002 04

Female power connector, high housing, with 6,3 mm fast-on crimp contacts



Contacts	Thread	Cable outlet	Fast-on sleeve	Ordering-No.
2+PE	PG 9	6–8 mm	0,5–1,5 mm ²	43 1708 011 00
			1,0–2,5 mm ²	43 1708 012 00
	PG 11	8–10 mm	0,5–1,5 mm ²	43 1708 013 00
			1,0–2,5 mm ²	43 1708 014 00
3+PE	PG 9	6–8 mm	0,5–1,5 mm ²	43 1708 015 00
			1,0–2,5 mm ²	43 1708 016 00
	PG 11	8–10 mm	0,5–1,5 mm ²	43 1708 017 00
			1,0–2,5 mm ²	43 1708 018 00

Specifications

Contacts	2+PE	3+PE
Wire gauge	min. 0,34 mm ² (min. AWG 22), max. 1,5 mm ² (max. AWG 16), screw termination/fast-on sleeve 0,5–1,5 mm ² , 1,0–2,5 mm ²	
Mechanical operation	> 50 Mating cycles	
Temperature range	– 30 °C /+ 110 °C	
Rated voltage	250 V	
Pollution degree	3	
Current (40°C)	10 A	
Contact plating	Ni (Nickel)	
Material of housing	PA	

Description

Female power connector, high housing, wired

Drawing

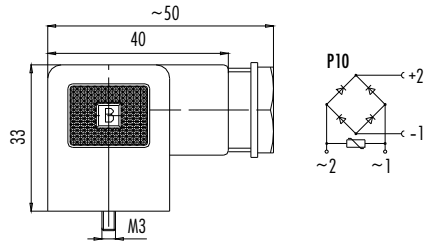

Contacts	Cable outlet	Wiring	Current	Ordering-No.
2+PE	6-8 mm	P10 230 V	2 A	43 1726 110 03
	8-10 mm			43 1726 112 03

Female power connector, low housing, wired, LED

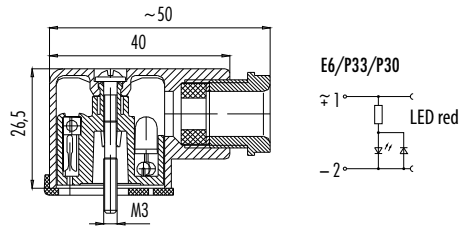

2+PE	6-8 mm	P10 230 V	10 A	E6 24 V	43 1714 135 03
				P33 110 V	43 1714 133 03
				P30 230 V	43 1714 131 03
	8-10 mm			E6 24 V	43 1714 136 03
				P33 110 V	43 1714 134 03
				P30 230 V	43 1714 132 03

Female power connector, high housing, wired, LED

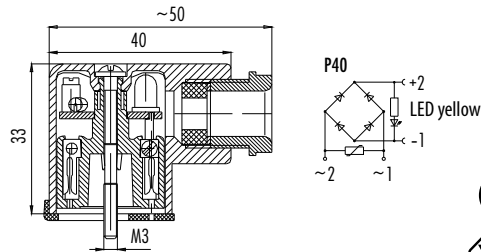

2+PE	6-8 mm	P40 230 V	2 A	43 1730 140 03
	8-10 mm			43 1730 142 03

Adapter, female power connector, low housing, M12

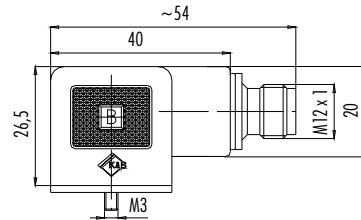

2+PE	-	-	60 V	4 A	99 5700 00 03
3+PE	-	-	-	-	99 5702 00 04

Component part drawing

Female power connector (PG 9, M16)

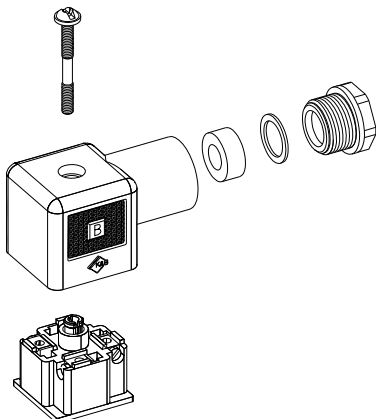

Female power connector with strain relief (PG 9)

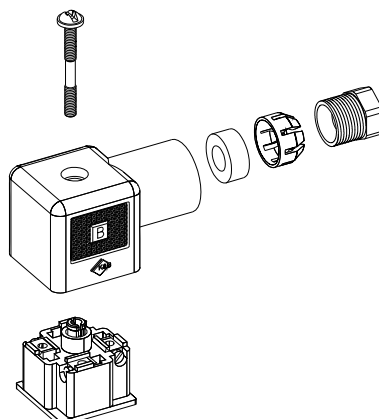

Contact arrangements

2+PE/3+PE contacts

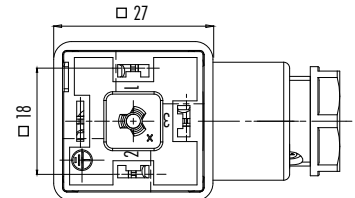

Description

Female solenoid valve connector, moulded



Drawing

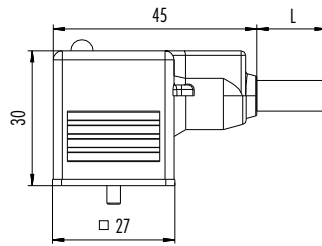

Contacts	Voltage	Current	Cable length, PUR	Ordering-No.
2+PE x 0,75	250 V	10 A	3 m	31 5234 300 000
			5 m	31 5234 500 000
3+PE x 0,75			3 m	31 5235 300 000
			5 m	31 5235 500 000

NEW

Female solenoid valve connector, moulded, wired, LED

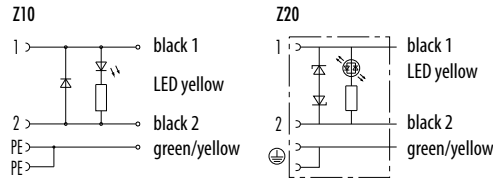

Contacts	Wiring	Current	Cable length, PUR	Ordering-No.
2+PE x 0,75	Z10 24V	10 A	3 m	31 5236 300 510
			5 m	31 5236 500 510
	Z20 24V		3 m	31 5237 300 520
			5 m	31 5237 500 520

NEW

Connecting cable female power connector – male cable connector M12

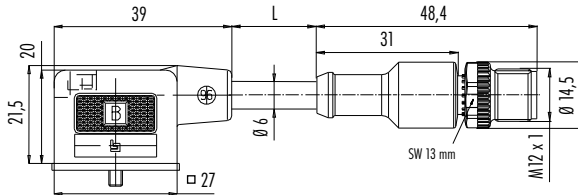

Contacts	Voltage	Current	Cable length, PUR	Ordering-No.
2+PE x 0,75	60 V	4 A	1 m	79 5700 10 03
			2 m	79 5700 20 03

Connecting cable female power connector, wired, LED – male cable connector M12

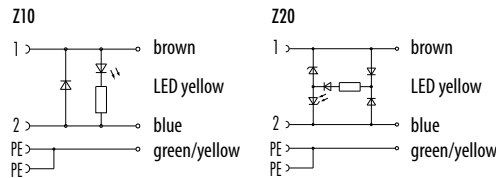

Contacts	Wiring	Current	Cable length, PUR	Ordering-No.
2+PE x 0,75	Z10 24V	4 A	1 m	79 5704 10 03
			2 m	79 5704 20 03
	Z20 24V		1 m	79 5706 10 03
			2 m	79 5706 20 03

Connecting cable female power connector – male angled connector M12

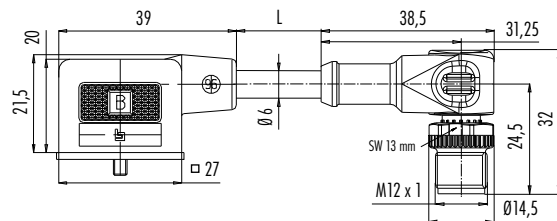

Contacts	Voltage	Current	Cable length, PUR	Ordering-No.
2+PE x 0,75	60 V	4 A	1 m	79 5701 10 03
			2 m	79 5701 20 03
3+PE x 0,75			1 m	79 5703 10 04
			2 m	79 5703 20 04

Connecting cable female power connector, wired, LED – male angled connector M12

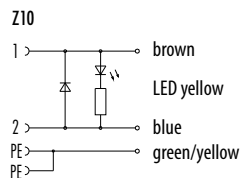

Contacts	Wiring	Current	Cable length, PUR	Ordering-No.
2+PE x 0,75	Z10 24V	4 A	1 m	79 5705 10 03
			2 m	79 5705 20 03

Description

Drawing

Contacts Ordering-No.

Male circular power connector

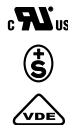
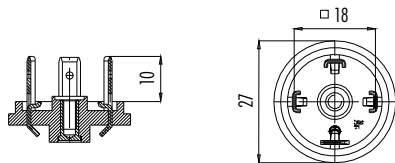

2+PE	43 1701 000 03
3+PE	43 1703 000 04

Male circular power connector, coupling ring M27 x 1,5

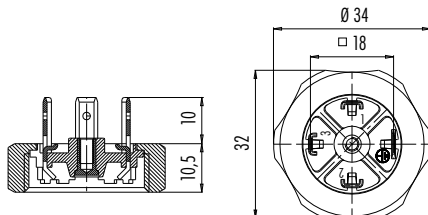

2+PE	43 1705 005 03
3+PE	43 1707 005 04
3+PE	43 1707 019 04 gold plated contacts

Male rectangular power connector, 2 mounting holes

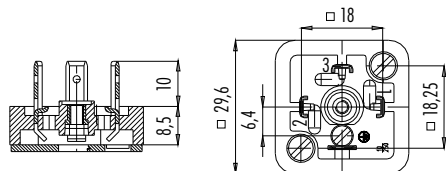

2+PE	43 1709 000 03
3+PE	43 1711 000 04

Male rectangular power connector, radius

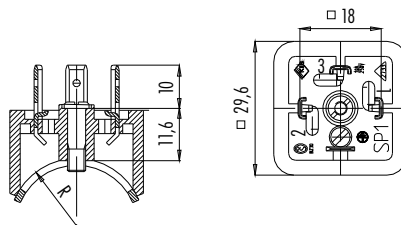

Contacts	Ordering-No.	Radius	Index (xxx)
2+PE	43 1717 xxx 03	17 mm	021
		20 mm	022
		22 mm	023
		25 mm	024
		28 mm	025
3+PE	43 1719 xxx 04	31 mm	026
		35 mm	027
		41 mm	028
		45 mm	029
		51 mm	030

Male rectangular power connector, 4 mounting holes

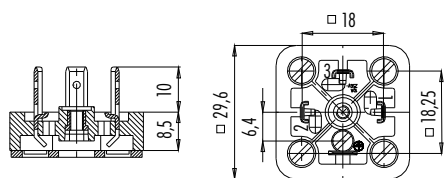

2+PE	79 5701 10 03
	79 5701 20 03
3+PE	79 5703 10 04
	79 5703 20 04

Contact arrangements

2+PE contacts, PE connected protective earth

3+PE contacts

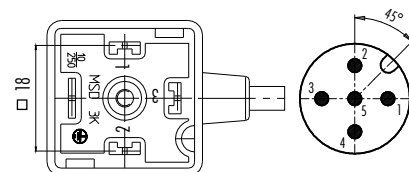
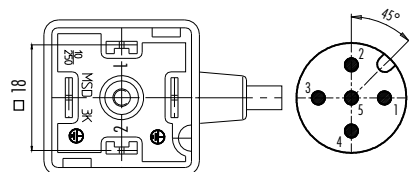

Colour of wire, moulded solenoid valve connectors and connecting cables

2+PE contacts	M12	3+PE contacts	M12
1	brown	1	brown
2	blue	2	blue
⊕	green/yellow	3	black
		⊕	green/yellow
		5	green/yellow

Description	Drawing	Material ¹⁾	Colour	Ordering-No.
Flat seal for female power connector		NBR Silicon	beige red	16 8085 000 16 8085 001
Flat seal for male power connector		NBR Silicon	beige red	16 8090 000 16 8090 001
Flat seal for male power connector		NBR Silicon	beige red	16 8089 000 16 8089 001
Flat seal for male power connector (version with radius)		NBR Silicon	beige red	16 8092 000 16 8092 001
Profiled seal for female power connector		NBR	black	16 8088 000
Profiled seal for female power connector		NBR	black	16 8114 000
Coupling ring for male power connector				Ordering-No. 16 8114 000
Knurled screw		16 8096 131 16 8104 131	(29,1 mm) (35,1 mm)	
		Material ¹⁾	Colour	Temperature range of seals
		NBR	beige	-40 °C/+ 100 °C
		NBR	black	-20 °C/+ 125 °C
		Silicon	red	-60 °C/+ 250 °C