

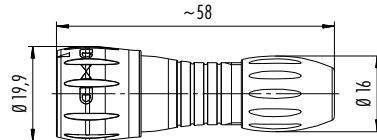

- Bayonet locking system
- 8 contacts
- Degree of protection IP67
- Solder termination
- Diameter 19,9 mm
- > 5000 Mating cycles
- Panel mount connectors:  
Degree of protection IP67  
even when not connected

Description	Drawing	Contacts	Cable outlet 2,5–4 mm	Cable outlet 4–6 mm
Male cable connector		8	99 0771 000 08	99 0771 001 08



Male cable connector

Contacts	Cable outlet 6–8 mm
8	99 0771 002 08

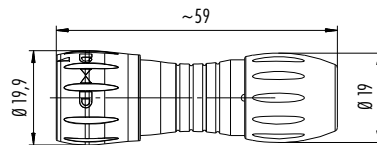

**Ordering-No.**

Female panel mount connector, solder	8	09 0774 000 08
--------------------------------------	---	----------------

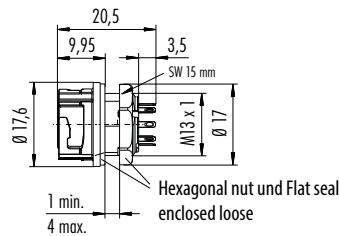

Female panel mount connector, dip-solder

8	09 0774 090 08
---	----------------

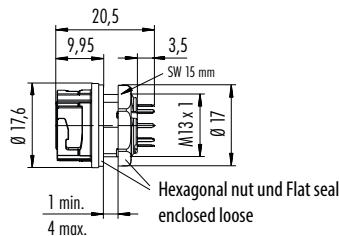

**Specifications**

Contacts	8
Wire gauge	0,25 mm <sup>2</sup> (AWG 24)
Mechanical operation	> 5000 Mating cycles
Temperature range	-25 °C / +85 °C
Rated voltage	175 V
Pollution degree	2
Rated current (40°C)	2 A
Contact plating	Au (Gold)
Material of housing	PA

## Component part drawing

Cable connectors

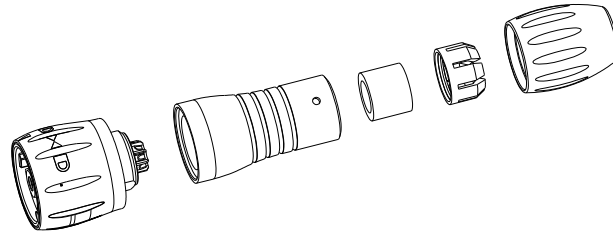

Male insert  
Sleeve  
Seal  
Pinch ring  
Pressing screw

Panel mount connectors

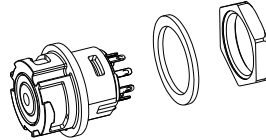

Female insert  
Panel mount connector housing  
with colour coding  
Flat seal  
Hexagonal nut

## Contact arrangement male insert (termination side)

8 contacts

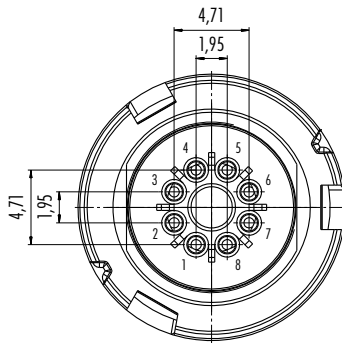

## Contact arrangement female insert (termination side)

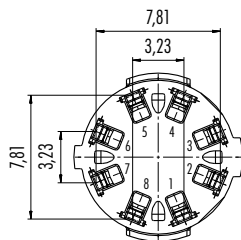

## Panel cut out

