

ELECTRICAL

- Matching Impedance: 75 unbalanced coaxial to 120 balanced twisted pair
- Bit Rates: 2Mbit/s and 8Mbit/s as G.703 Line Code
- Return Loss: 2Mbit/s and 8Mbit/s exceeds G.703 requirements
(in both directions) (>25dB from 51kHz - 3072kHz)
- Insertion Loss: <0.2dB from 51kHz to 3072kHz and <0.3dB from 211kHz to 12.672MHz in both directions
- Cross Talk: >65dB from 51kHz to 12.672MHz
- Pulse Shape: 2Mbit/s and 8Mbit/s as per G.703
- Isolation Voltage: 250V DC between input and output
- Signal Levels: 2.37V nominal peak voltage at 2Mbit/s and 8Mbit/s at the coaxial end as per G.703

MATERIALS

- Panel: Steel zinc coated, powder coated black
- Coax Connector Outer Contact: Brass Alloy AS 1567 Type 385. Finish Cu/Ni/Au
- Coax Connector Insulator: PTFE
- Coax Connector Inner Contact: Beryllium Copper. Finish Cu/Ni/Au
- Panel Insulator: Thermoplastic, Black
- Telco Connector Housing: Thermoplastic, Black
- Telco Connector Contacts: Copper Alloy. Finish Ni/Au
- Telco Connector Shield: Die Cast. Finish Ni

COAXIAL CONNECTOR (75)

1.0/2.3 Series: To IEC 169-29

TELCO CONNECTOR

Type: Shielded, 50 Pin Receptacle

ENVIRONMENTAL

Working Temperature: -30°C to 75°C
 RoHS Compliance: To EU Directive 2011/65/EU

MOUNTING OPTIONS

Mounting brackets are reversible to allow either the coaxial connectors or the Telco sockets to be mounted to the front. The brackets also allow the panel to be recessed up to 40mm. Optional brackets for mounting in ETSI and 23" racks are available.

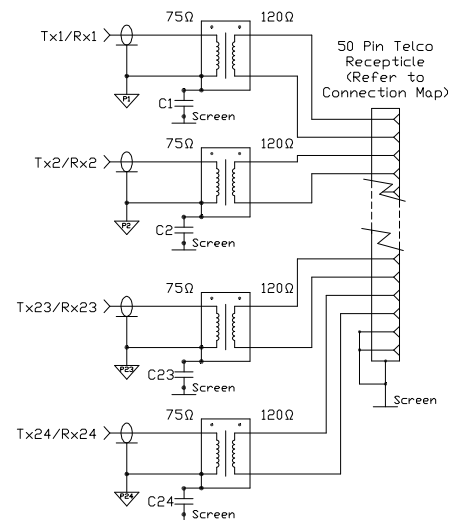

Balun Circuit For Each 50 Pin Telco
 Circuit Isolated From Chassis